



WATSON MINI

USER MANUAL

CONTENTS

Welcome	3
Connecting	4
Cleaning	4
Resources	5
Support/Software	
SDK Download Link	
Scanning	6
Finger Conditions	
Hand Orientation	7
Correct Placement – Top View	
Finger Contact	8
Correct Placement – Side View	
Flat Scanning	9
Finger Position	
Flat Scanning	10
Thumb Capture	
Roll Scanning	11
Finger Placement	
Roll Scanning	12
Finger Position	
Warranty	13
Compliance	13

WELCOME!

Thank you for purchasing Watson Mini, Integrated Biometrics' patented Light Emitting Sensor (LES) fingerprint scanning solution. Watson Mini is the most durable, highest performance FAP 60 FBI Appendix F-certified single-print live scanning solution.

Please read this manual thoroughly before using your Watson Mini to review proper steps for unit operation and capture processes. Your Integrated Biometrics reseller and the IB team are ready to answer any questions you may have!



CONNECTING

CONNECT USB TO THE DEVICE

Connecting Watson is easy!

1. Download and install the latest IBScanUltimate SDK
2. Connect Watson
 - USB Type A – Connects to PCs
 - Micro USB – Connects to Android phones and tablets
 - Molex – Embedded options
3. Integrated Biometrics provides a variety of test applications for demonstration. IBScanUltimate SDK includes demonstration applications for supported platforms and source code for ease of deployment.

CLEANING AND DISINFECTION

For proper cleaning and disinfection of IB products, visit:

<https://integratedbiometrics.com/cleaning>

RESOURCES

SUPPORT/SOFTWARE DEVELOPMENT

The IBScanUltimate Software Development Kit (SDK) is a set of robust tools that empower solution providers with the ability to deploy compelling LES biometric acquisition applications. The SDK includes support for a variety of operating systems and exceeds the needs of the most challenging environments.

The SDK includes Application Programming Interface (API) documentation, IB software components, demonstration applications and source code for each platform. Demonstration source code is a simple reference for integrators to rapidly develop solutions using Integrated Biometrics' LES technologies. We encourage you to review the included materials and explore the limits of creativity when designing custom biometric solutions.

If you have any questions, please contact your Integrated Biometrics reseller or the IB team. We'll be glad to provide assistance during solution development.

SCANNING

FINGER CONDITIONS

VERY MOIST FINGERS

- Result: Images too dark, poorly defined. Indicates too much moisture on the fingers.
- Solution: Dry the fingers with a towel or cloth before fingerprint capture.
- The resultant images will be lighter and the NFIQ quality scores will improve.

VERY DRY FINGERS

- Result: Images take several seconds to appear or contrast appears lighter than desired.
- Solution: Rub a small amount of moisturizer on the fingertips. (Do not slather.)
- The resultant images will be darker and the NFIQ quality scores will improve.
- Gentle or light contact with the plate is recommended in scanning. Placing extra pressure on the hand is not recommended.
- Avoid using hand sanitizers, alcohol based lotions, and baby wipes prior to scanning.

BEST PRACTICES

- Never put a wet hand on the scanner i.e., just washed and not thoroughly dried, holding a bottle of liquid that leaves condensation on your hand. Hands should be wiped dry.



Normal Fingerprints



Wet Fingerprints



Dry Fingerprints

HAND ORIENTATION

CORRECT PLACEMENT – TOP VIEW

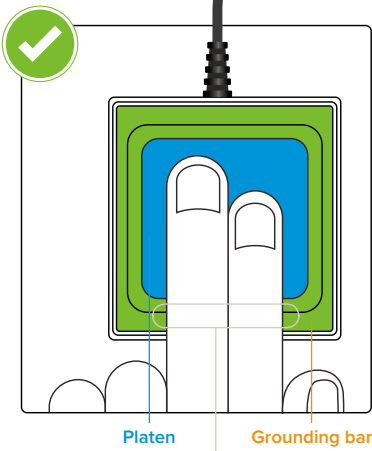

Fingers should be pointing at cord and grounded firmly against the platen and grounding bar.

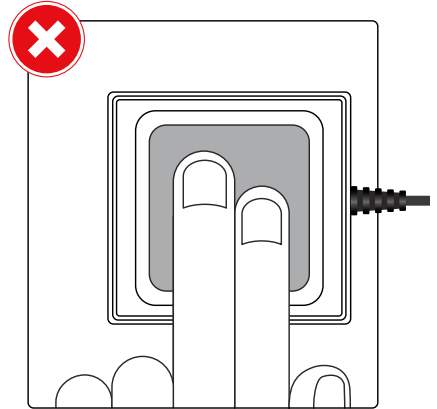
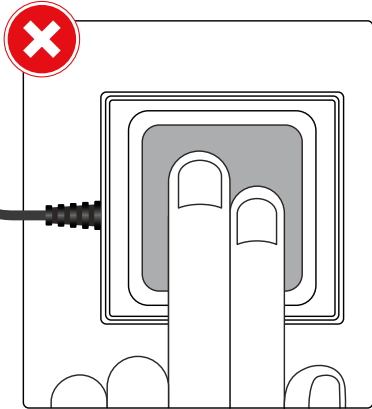
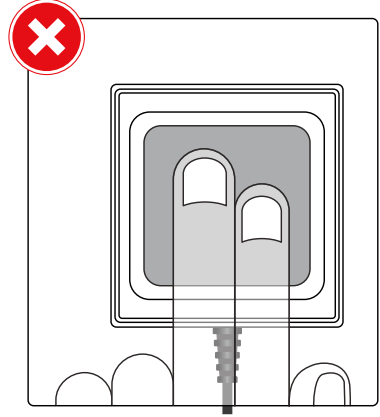

FINGER CONTACT

CORRECT PLACEMENT – SIDE VIEW

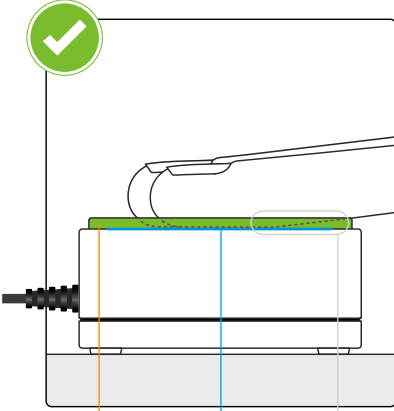

Grounding bar Platen

Fingers should be pointing at cord and grounded firmly against the platen and grounding bar.

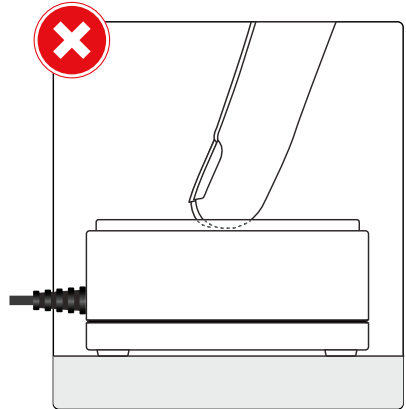
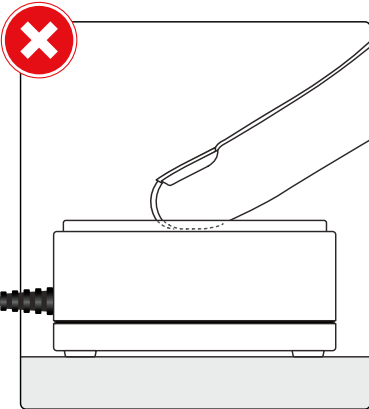
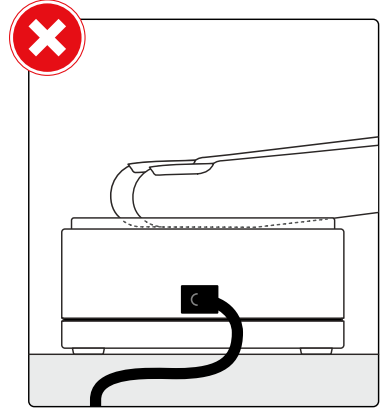

FLAT SCANNING

FINGER POSITION

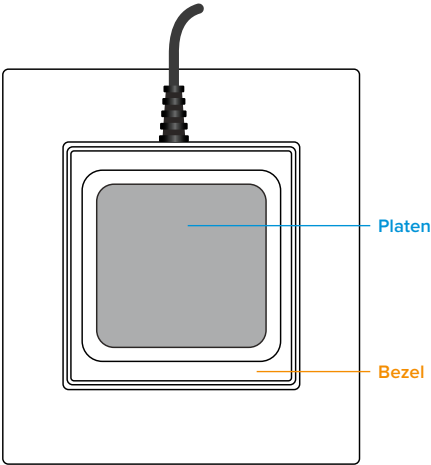

Ready to Scan

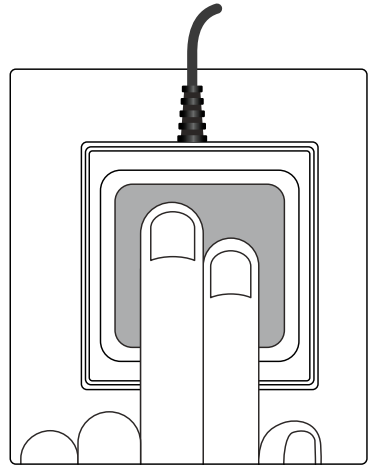

Scan finished.
Put your left finger firmly on the bezel for proper contact.

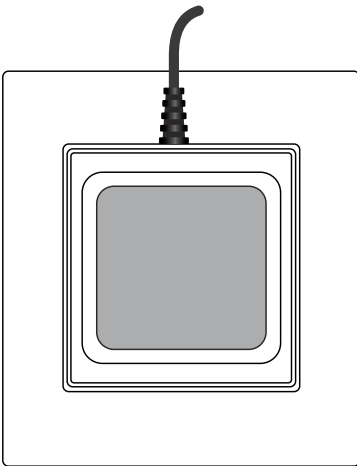

Ready to Scan

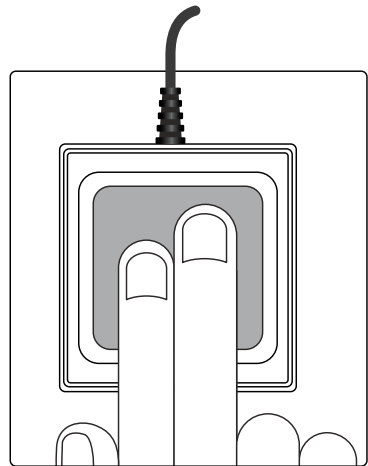

Scan finished.
Put your right finger firmly on the bezel for proper contact.

FLAT SCANNING

THUMB CAPTURE

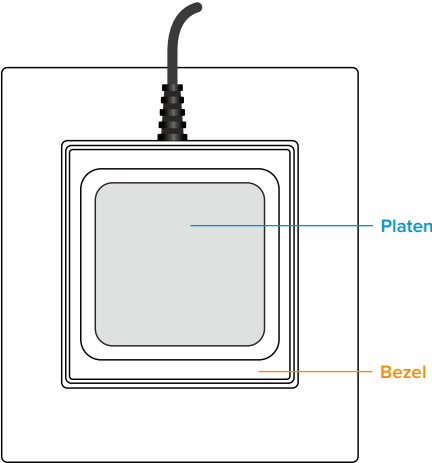

Ready to Scan

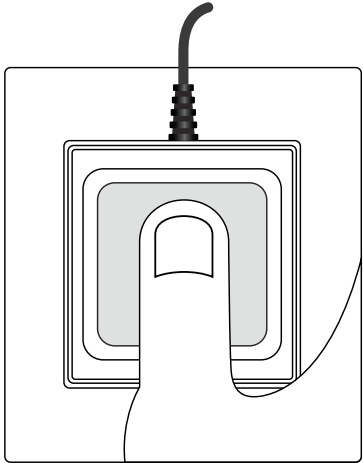

Thumb Scan Complete.
Place bottom of right thumb firmly against the bezel to ensure proper contact.

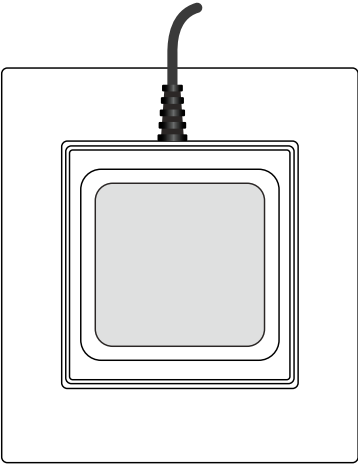

Ready to Scan

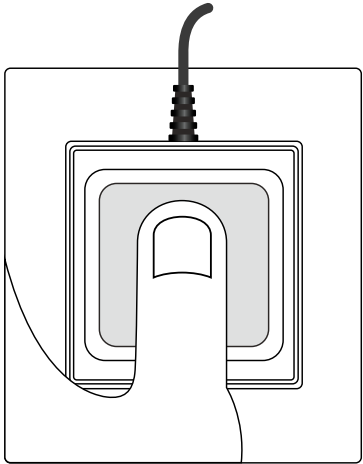

Thumb Scan Complete.
Place bottom of left thumb firmly against the bezel to ensure proper contact.

ROLL SCANNING

FINGER PLACEMENT

When performing rolls, place indicated finger firmly against the bezel and platen to ensure proper contact.

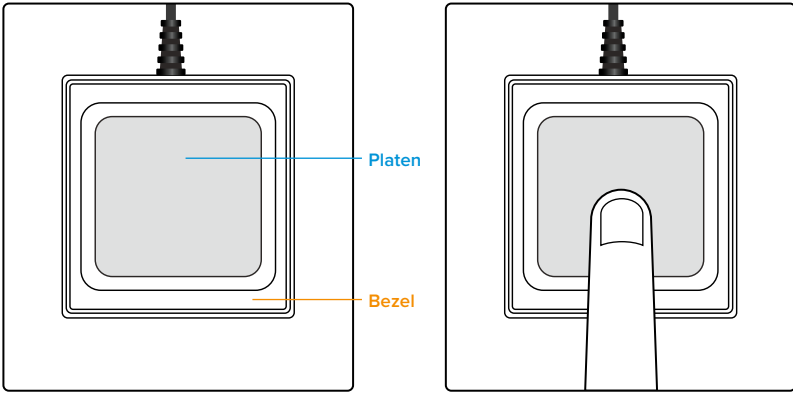

Ready to Scan - First Finger

Finger Placement

- Put your finger firmly on the bezel and maintain contact with the bezel.
- Roll your finger to the left at a 45-degree angle without losing physical contact with the bezel and platen.

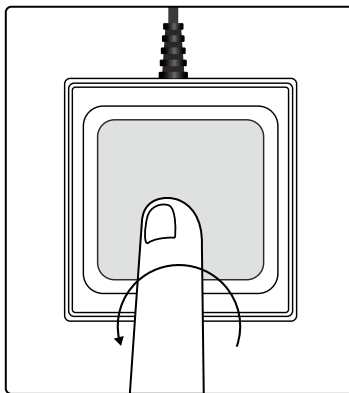

Roll Left Complete

NOTE: Optimal scanning requires stopping at +/- 45 degrees from flat.

ROLL SCANNING

FINGER POSITION

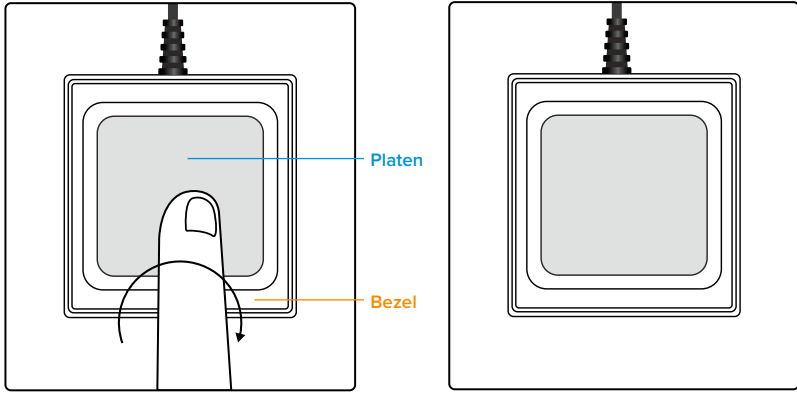

Ready to Scan Next Finger

- Roll your finger to the right at a 45-degree angle without losing physical contact with the bezel and platen.

EXAMPLES OF ROLLED FINGERPRINTS

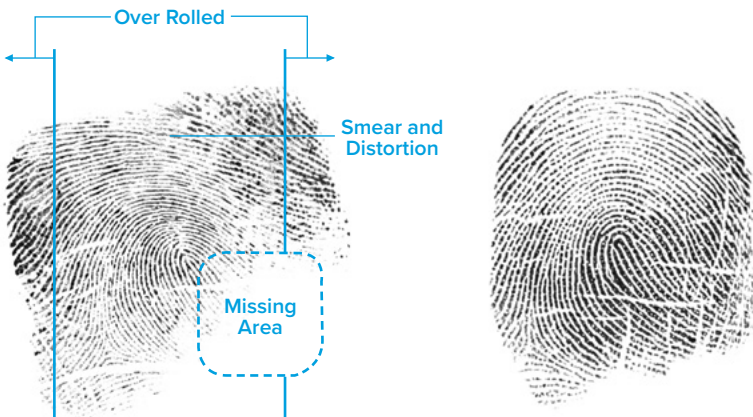

WARRANTY

All products are guaranteed for 12 months from the date of delivery.

Additional year warranties available. Check with your dealer.

See the warranty here: <https://integratedbiometrics.com/warranty>

COMPLIANCE

FCC

This equipment has been tested and found to comply with the limits for a Class B digital device, pursuant to part 15 of the FCC Rules. These limits are designed to provide reasonable protection against harmful interference in a residential installation. This equipment generates, uses and can radiate radio frequency energy and, if not installed and used in accordance with the instructions, may cause harmful interference to radio communications. However, there is no guarantee that interference will not occur in a particular installation. If this equipment does cause harmful interference to radio or television reception, which can be determined by turning the equipment off and on, the user is encouraged to try to correct the interference by one or more of the following measures:

- Reorient or relocate the receiving antenna.
- Increase the separation between the equipment and receiver.
- Connect the equipment into an outlet on a circuit different from that to which the receiver is connected.
- Consult the dealer or an experienced radio/TV technician for help.

Caution: Any changes or modifications not expressly approved by Integrated Biometrics could void the user's authority to operate this equipment legally under FCC regulations.



WORLD-CLASS TECHNOLOGY

LES technology empowers energy-efficient, compact, and durable biometric scanning solutions unique to the market. Ready to deploy in any environment under any conditions, Integrated Biometrics' scanners are the choice for high performance applications.

WATSON_{MINI}

Integrated Biometrics, Inc.

+1 (888) 840-8034 · technical@integratedbiometrics.com

www.integratedbiometrics.com